

the power center  
**Series A  
 Power Tray + Pack**

INSTALLATION INSTRUCTIONS

Designed by Poppin in NYC

Included in the boxes:

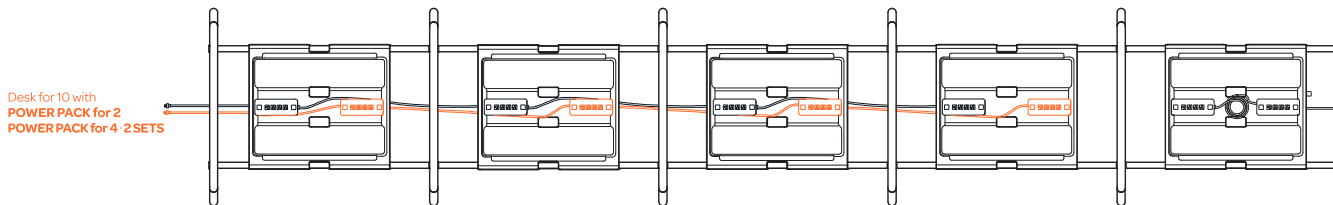
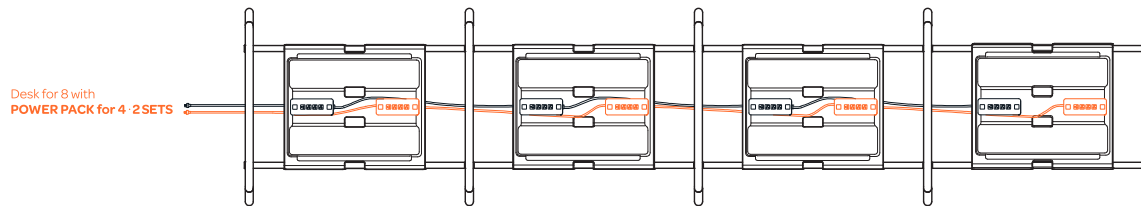
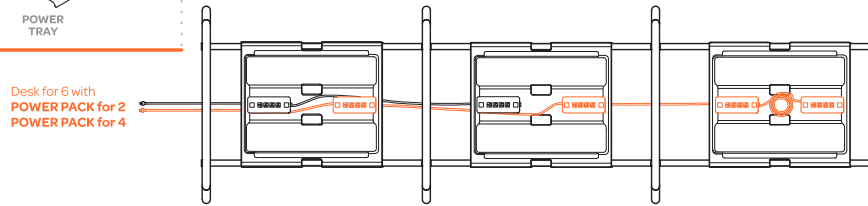
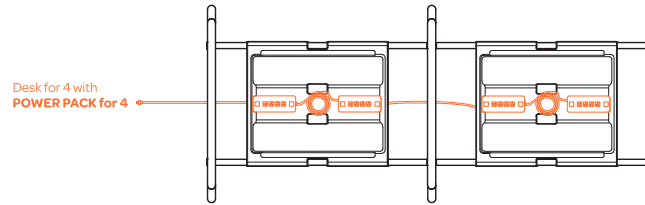
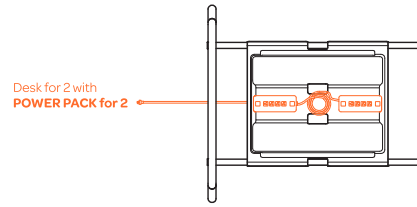
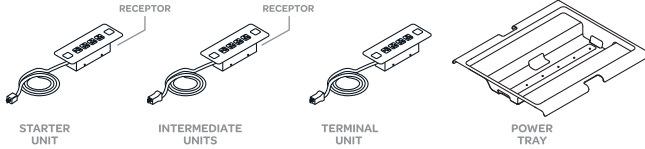

INSTALLATION INSTRUCTIONS

- 4.1 Hang the Series A Power Tray onto the beams, centering them between the desk legs.
- 4.2 Position the **terminal unit** into the tray, at the end of the desk run. Coil excess cord inside the tray as necessary.

**HEADS UP!**  
 Begin with the Series A Desk assembly instructions document. On page 3, complete steps 1-4

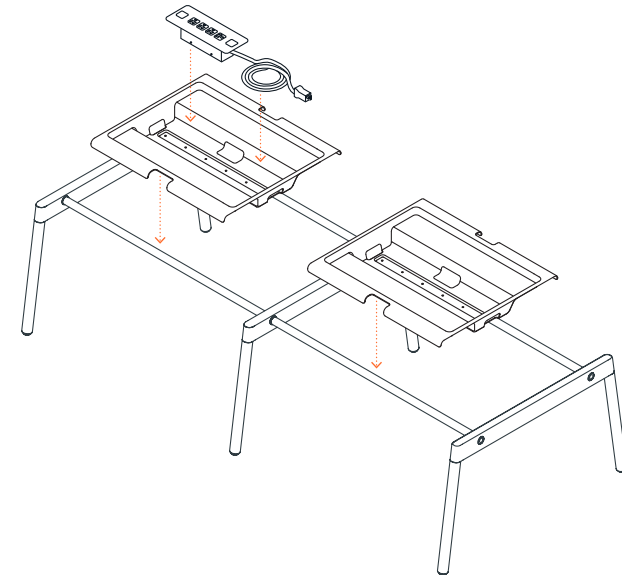

- 4.3 a. If installing a 2 pack, position the starter unit in the tray and connect the red-tipped cable from the **terminal unit** into the red receptor on the **starter unit**. Skip to step 4.5  
 b. If installing a 4 pack, identify the 1st **intermediate unit** by its green receptor and position in the appropriate tray. Refer to the desk configurations illustrated to the right. Connect the green-tipped cable on the **terminal unit** to the green receptor on the first **intermediate unit**. Coil excess cord inside the tray as necessary.
- 4.4 Repeat Step 4.3b with the 2nd **intermediate unit**, identified by its orange receptor, and the **starter unit** (with red receptor).
- 4.5 Plug the **starter unit** into the power outlet. Test each unit for power flow.
- 4.6 Attach all units to the tray(s) using thumbscrews provided.

Complete any additional cable routing required, like data or video, before installing desk tops. Resume desk assembly at step 5